

JBC

www.jbctools.com

Product
website



INSTRUCTION MANUAL



B·IRON DUAL 500

Dual Battery-Powered Soldering Station

This manual corresponds to the following references:

BISS-5B* - with Portable Display
BISS-5QB* - without Portable Display

* Depending on customer requirements, various power cords are available, suitable for:
 - 120V - N. America / Taiwan
 - 230V - India / Europe / United Kingdom

Packing List

The following items are included:



Charging-Base with Charging-Holders already assembled 1 unit



C210 Cartridge 2 units
 Ref. C210001 (tip \varnothing 0.3 mm)



B-500 Handle for B-IRON 2 units
 Ref. B500-B

Includes Handles + B1596 Safety Caps + OB4000 Sealing Plugs + B5050 Grips + fitters.



Brass Wool for B-IRON Charging-Base 1 unit
 Ref. CL0300

Already assembled in the charging base.



B-IRON Display Holder 5" to 7" 1 unit
 Ref. 0030723

Includes fixing knob.



Cable USB-A to USB-C ** 1 unit
 Ref. 0032705



Power Cord * 1 unit
 Ref. 0027380 120V - N. America / Taiwan
 0027381 230V - India
 0027382 230V - Europe
 0027378 230V - United Kingdom



Portable Display 7" for B-IRON ** 1 unit
 Ref. PDS-B

Quick Start Guide 1 unit

Manual 1 unit
 Ref. 0034645

* One power cord included according to customer requirements.

** Not included in BISS-5QB.

Important

Please read this manual and its safety guidelines thoroughly before using the product.

Note: Even if the display is turned off and the charging base is disconnected from the mains, the tool remains operational as long as the batteries are charged, even when the cartridge is taken out.



The tool turns off automatically only under the following conditions:

- The tool is out of the charging holder (no safety cap on) and remains completely still for 5 minutes (see page 8).
- The tool has the safety cap on and remains completely still for 60 minutes (see page 9).
- The tool is in the charging holder and the charging base is disconnected from the mains.

The tool can be manually switched off and on by tapping the tool power button on the display (see page 9)

Features and Connections



* Not included in ref. BISS-5QB

Features and Connections

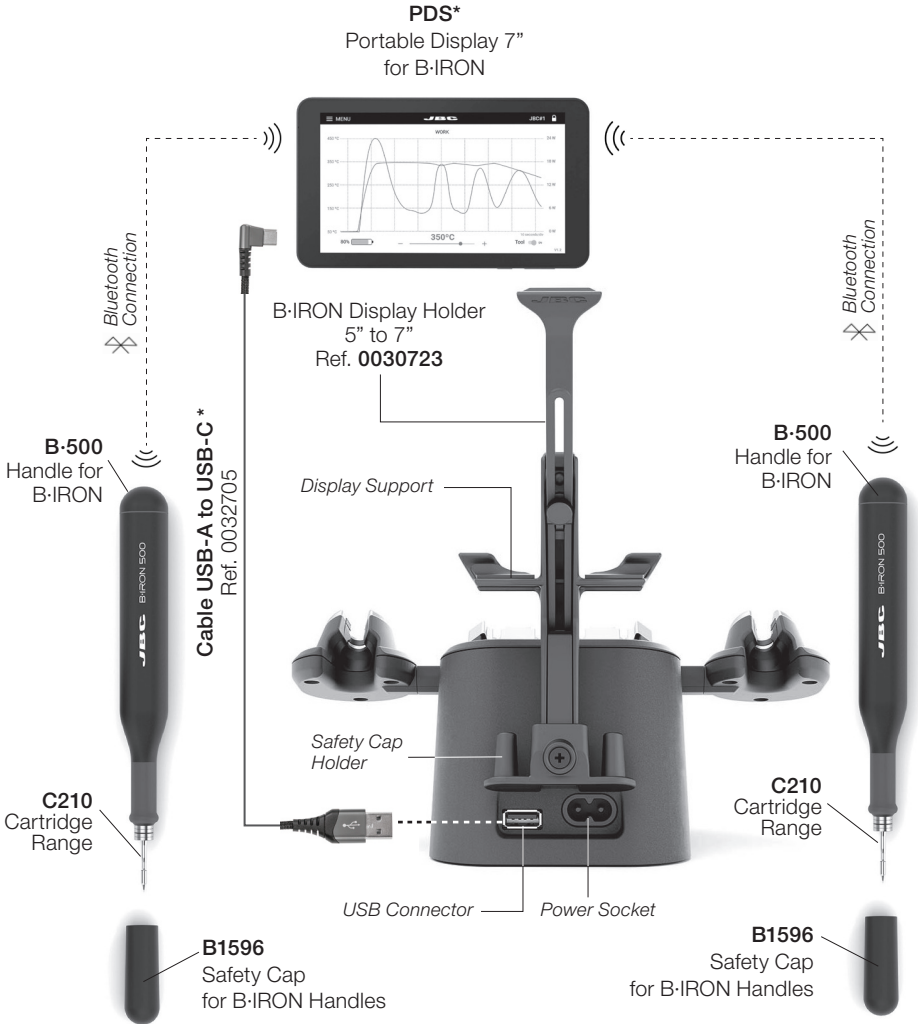

ESD Safe Connection

Note: All B-IRON components comply with CE standards, but the tool by itself is not grounded. Therefore, to comply with ESD regulations, the user of the B-IRON tool must be ESD-compliantly grounded.

JBC offers ESD tablemats, earthing cables, plugs and wristbands. More information on www.jbctools.com.

Station Setup

Display Holder Assembling

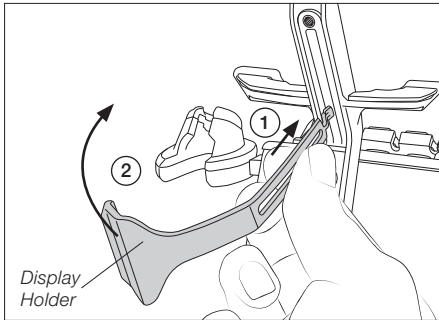

Insert the thin end of the display holder into the upper area of the rear rail of the charging base (1). Then carefully rotate the display holder 90 degrees (2) until it stands vertical.

Display Holder Setting

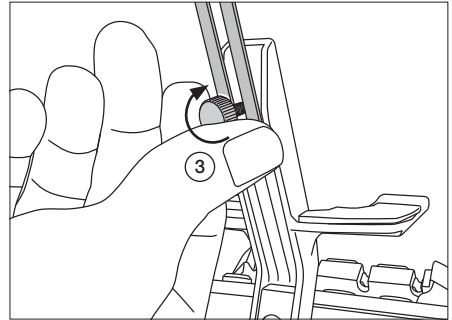

Insert the fixing knob (3) and tighten it just enough so that it stays in place but the display holder can be moved.

Base and Display Connection

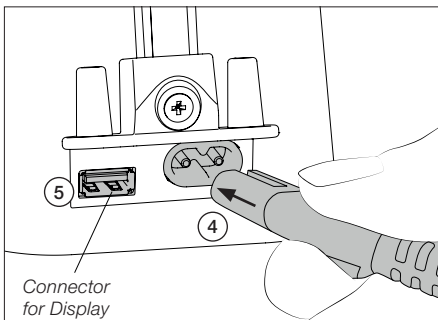

Connect the charging base to the mains (4).

The display can be connected to the USB port (5) with the provided USB cable to keep it charging while working.

Display Placing

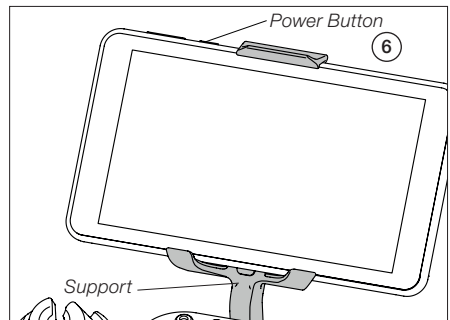

Place the display on the support with its buttons facing upwards. Adjust the height of the display holder tighten the fixing knob.

Turn on the display by holding down the power button for a while (6) and then open the B-IRON app*:



* **Note:** The app can also be downloaded to your own devices. To know how, see section “Installing and Updating the B-IRON App”.

Station Set Up *(continuation)*

Cartridge Exchanger

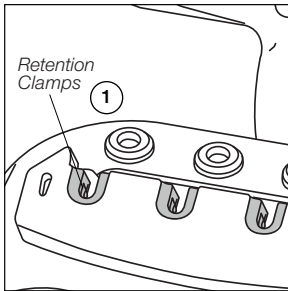

The cartridge exchanger allows inserting / changing cartridges safely without switching the tool off. Cartridges are held in place thanks to the retention clamps (1).

The exchanger is suitable for C115 and C210 cartridges.

C115 Cartridges

The holding area of C115 Cartridges is delimited by the two rings at the cartridge shaft (x).

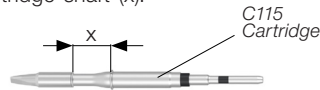

C210 Cartridges

The holding area of C210 Cartridges goes from the collar of the tip until the cartridge begins to widen (x).



Cartridge Changing

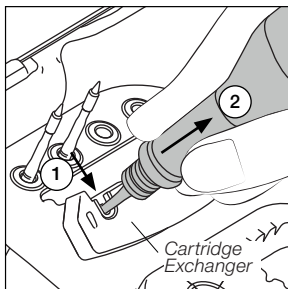

Place the tool with the cartridge over the cartridge exchanger slots and press down (1) until it clicks. To remove the cartridge pull the handle out (2).

To insert a cartridge, carry out the same steps as before in reverse order.

Note: Cartridges must be inserted up to the mark for a proper connection and functioning.

Cartridge Fixing

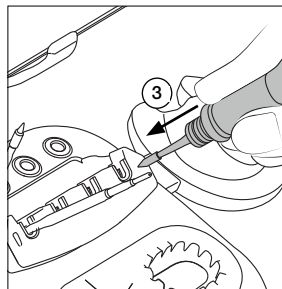

Gently press the tip against the holes on the sides of the cartridge exchanger (3) to ensure that the cartridge is appropriately inserted.

Tool Charging

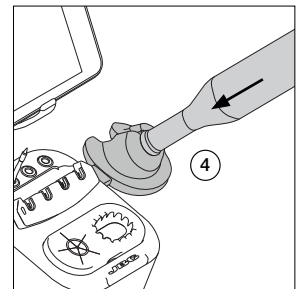

Place the tool in the charging holder (4) to charge it. A beep will sound when the tool is properly placed and charging. The volume can be adjusted using the left button on the display.

Important: Charge the tool completely before using it for the first time.

A full charge takes:

- 30 min for B-100
- 60 min for B-500
- 30 min for B-NANO
- 45 min for B-TWEEZERS

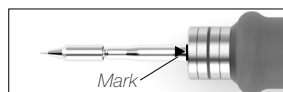

Operation

Thanks to the intelligent heat management, the cartridge tip recovers temperature extremely quickly.

This allows reducing the tip temperature when the device is not in use, resulting in a longer tip lifespan.

When the tool enters Sleep (1) or Hibernation (2) Modes, the tip temperature lowers automatically below the solder-melting-point temperature.

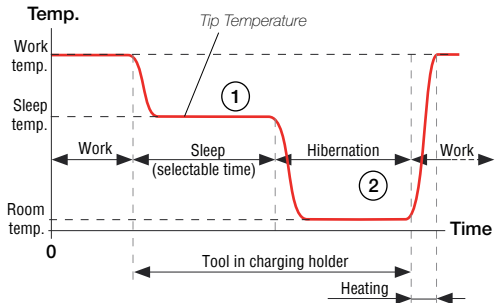

Tool Status

Tip Temperature

The tool can go into a number of statuses under different circumstances (see the diagram on the next page). Depending on the status, the cartridge tip reaches different temperatures:

Tool Status	Tip Temperature
Sleep and charging	Cools down to the set Sleep temperature. Selectable between 70 °C and 150 °C.
Hibernation and charging	Cools down to room temperature.
Working	Heats up to the set work temperature.
Resting without cap	Cools down to room temperature (after 5 min of being completely still).
Tool with cap on	Cools down to room temperature.
Hibernation	Cools down to room temperature.
Shut off	Remains at room temperature (tool is shut off).

Sleep and Charging

Sleep Mode can be activated/deactivated (1). If it is activated and the tool is placed in the charger, the tip cools down to sleep temperature and the tool keeps charging.

Hibernation and Charging

If Sleep Mode is not activated and the tool is placed in the charger, it goes into Hibernation. The tip cools down to room temperature and the tool keeps charging.

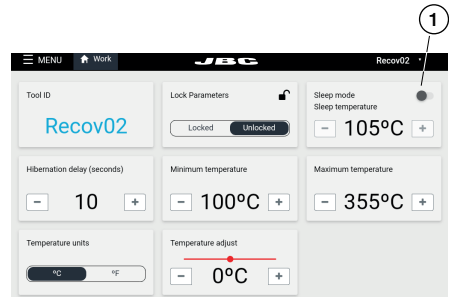

Tool Status *(continuation)*

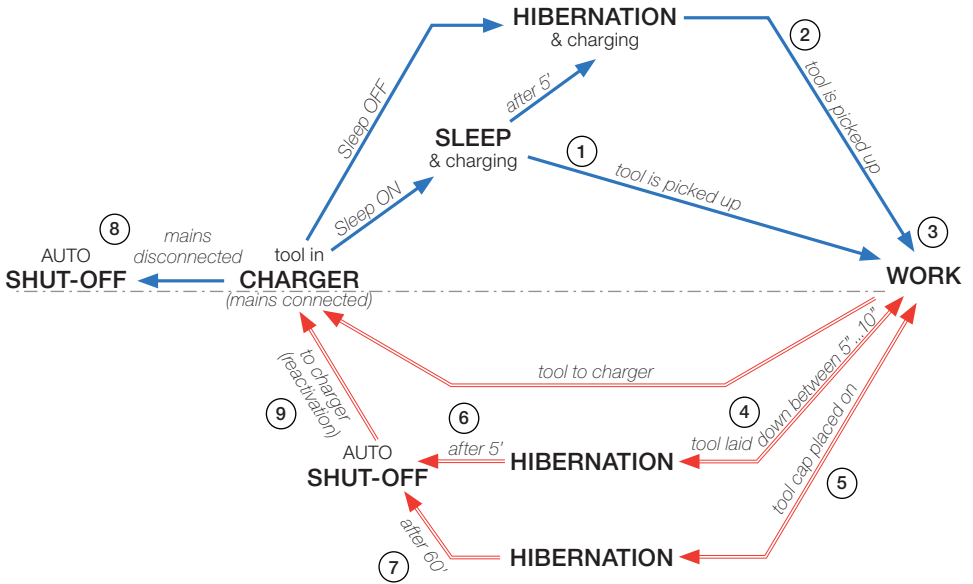

Work

When the tool is taken out of the charger while in Sleep (1) or Hibernation (2) Modes, the cartridge tip heats up to the set work temperature and the tool is ready to use (3).

Hibernation

The tool goes into Hibernation Mode in two different cases:

- After working, when the tool is laid down (4) and is resting between 5 and 10 seconds (time is adjustable).
- After working, when placing the cap on the tool (5).

Note: Before the tool enters Hibernation Mode, it can be picked up to work with it and the cartridge tip heats up to work temperature.

Auto Shut-off

The tool shuts off automatically in three different cases:

- When the tool (without the tool cap) is laid down and remains completely still in Hibernation Mode for 5 minutes (6).
- When the tool (with the tool cap on) remains completely still in Hibernation Mode for 60 minutes (7).
- When the tool is in the charger and the charging base is disconnected from the mains (8).

Tool Status *(continuation)*

Tool Reactivation

Once the tool has automatically shut off, place it back in the charging holder (9) to reactivate it *(see diagram on previous page)*.

Manual Tool Shut-Off

Besides the “automatic shut-off” feature, the tool can also be manually switched off by tapping the tool power button on the display. When it is switched off, the cartridge cools down to room temperature.

Note: To switch the tool back on, tap the same button on the display.

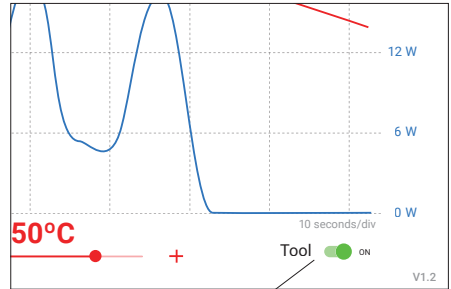

Tool On/Off Button

Safety Cap

Safe Tool Transportation

Thanks to the tool's safety cap, B-IRON tools can be carried around safely, even with the cartridge inserted.

When the cap is placed onto the tool, it goes into Hibernation Mode immediately and the cartridge tip cools down to room temperature.

Note: The purpose of the cap is to allow safe transport, not storage.



Safety Cap Holder

While the tool is in use, the safety cap can be stored on the cap holder located on the back of the charging base.

There is space for two caps.



Tool Connection

Make sure that the charging base is connected to the mains.

Note: Tools supplied with a station are already connected to the station.

Scanning another tool (*this process can take a while*): Place the tool in the charging holder to activate it. The status light band color indicates the charge level (see table below).

If the scanning process does not run automatically, tap “scan” (6) on the display while the tool remains in the charging holder. When the tool is shown in the device list on the display, select it (11) and tap “connect” (7). Now the tool is ready for soldering.

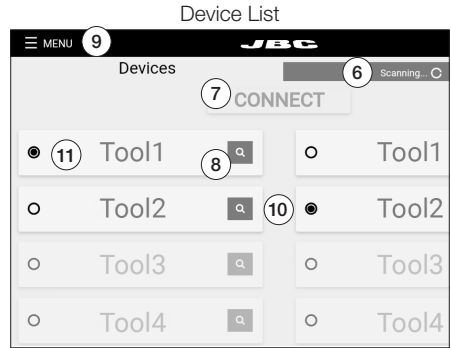

Tool search function:

When in doubt of which tool corresponds to the tool’s name, use the tool search function. Tap on the magnifying glass symbol (8) next to the tool’s name. The light band on the corresponding tool blinks in blue for five seconds to identify it.

Working with two tools

 (*works also for charging bases with only one charging holder*):

It is possible to connect up to two tools at the same time. If a tool is already connected, first disconnect it from the device by selecting “Menu” (9) and tapping on “Disconnect”.

Place the second tool in the charging holder and scan it (6). The second tool is also shown in the device list on the display (10). To work with two tools, select one from the left-hand column (11) and the other one from the right-hand column (10). Then tap on “connect” (7).

Status Lightband

The status lightband on the tool indicates its status (see table on the right).



Color	Tool Status
Green	More than 50% charged
Orange	Between 20% and 50% charged
Red	Less than 20% charged
Green blinking	Charging (more than 50% charged)
Orange blinking	Charging (between 20% and 50% charged)
Red blinking	Charging (less than 20% charged)
No color	Safety cap on the handle and/or power off
Blue blinking	Locate Tool function activated

Workscreen

The workscreen shows a graph of the tip temperature and power supplied to the tip updated in real time. It allows modifying the tool working temperature, checking the battery status and turning the tool in use on and off.

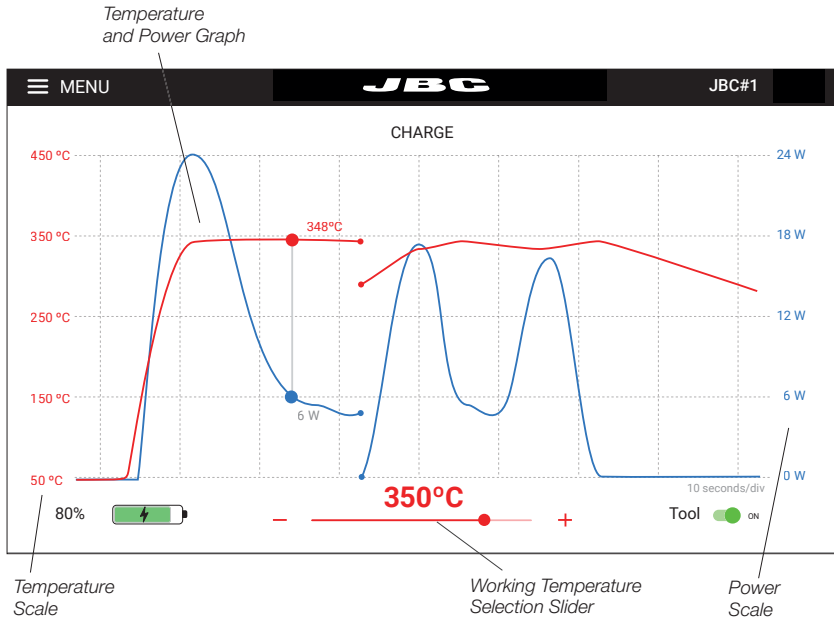

Graph and Automatic Data Display

The graphs of temperature and supplied power start automatically as soon as the tool is lifted from the charging base.

The graph display can be paused while working by tapping the screen on the graph area. While the automatic display is on hold, the temperature/power values can be checked at a certain point of the graph by tapping on the desired position on the display screen.

Note: Pausing the automatic display by tapping on the screen does not stop the tool from heating up, and the tip will remain at the selected working temperature. The graph display automatically continues after 5 seconds.

The graph can be moved to the left or right by swiping the touch screen sideways with one finger.

Working Temperature Modification

The working temperature can be modified using the slider below the graph ($\pm 5\text{ }^{\circ}\text{C}$ / $\pm 10\text{ }^{\circ}\text{F}$).

Workscreen (continuation)

Connected Tool and Tool Selector

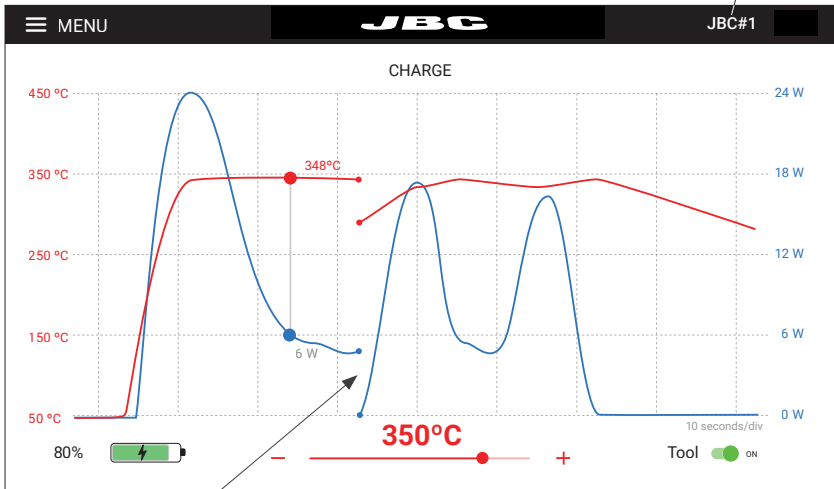

When the tool is not in use
the graph stops recording

Stopping Data Display

When the tool is placed in the charging holder or when it enters Hibernation Mode, the data display stops.

The display starts again automatically when the tool is lifted from the tool holder and the graph is automatically displayed again at the point where the previous display stopped, leaving a small gap on the graph between the last registered value and the new starting point.

Working with Two Tools

When working with two tools, to switch between the two graphs, tap on the tool selector (upper-right corner of the display) and select the desired tool from the drop-down menu.

It is also possible to alternate both graphs by simply lifting one tool or the other from the tool holder. The display will automatically show the graph and information of the tool in use.

Note: All menu items are explained in detail starting at section “Menu”.

Menu

Tool Connected:

Once at least one tool has been linked, the menu expands and shows more options.

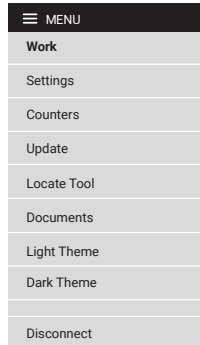

No Tool Connected:

Before any tool is connected to the station or after the last tool has been disconnected, the menu offers these options.

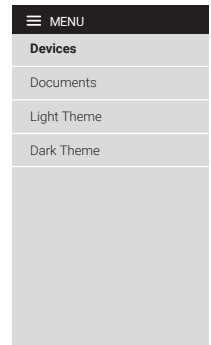

Work:

Takes the user to the workscreen (see section “Workscreen”).

Settings:

The B:IRON app offers an intuitive user interface, which provides quick access to several station parameters (see next page).

Counters:

The Counters section allows the user to consult data and counts on charges, work state periods, Sleep Mode periods, errors... The data can be consulted either by time periods or by number of times a certain event has occurred.

Update:

Allows updating the firmware of the soldering station. To know more about the updating process, see section “Updating the Firmware”.

Locate Tool:

When in doubt of which tool corresponds to the tool's name, use the tool search function, tapping on “Locate Tool”. The light band on the corresponding tool blinks in blue for five seconds to identify it.

Documents:

User manuals related to the station or to the tools can be consulted in this section or on JBC's website: www.jbctools.com

Light/Dark Theme:

Allows the user to switch between dark and light display modes.

Disconnect:

Disconnect the tool in use. If only one tool is connected, after disconnecting it, the app returns to the device list display.

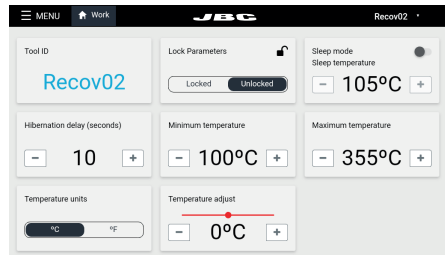

Settings

Parameter	Description
Tool ID	Allows modifying the tool identifier.
Lock parameters	Allows locking the parameters of the station using a four-digit code. The default code is 0105, but a new code can be set by simply entering some other four digits of choice when locking the parameters.
Sleep Mode / Sleep temperature	Set Sleep Mode on/off. The tip temperature drops only to the selected Sleep temperature when placed on the tool holder.
Hibernation delay	Set Hibernation delay from 5 to 15 sec. The countdown starts when the tool remains inactive (no movement).
Minimum temperature	Define the minimum selectable working temperature.
Maximum temperature	Define the maximum selectable working temperature.
Temperature units	Allows changing the units of temperature measurement between degrees Celsius and degrees Fahrenheit.

Compatible Cartridges

B-500 Handle works with C210 Cartridges. Find the model that best suits your soldering needs on www.jbctools.com

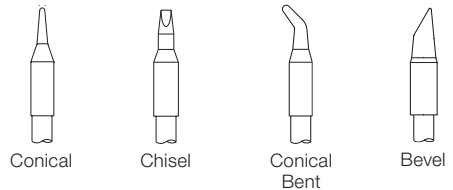

Inserting C210 Cartridges

Push the cartridges inside the handle until the reference mark is aligned with the edge of the handle.

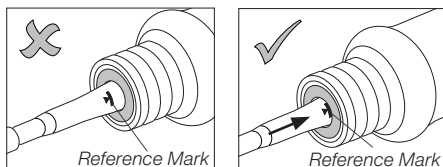

C210 Cartridge Holder

The cartridge holder (4x slots) is used to store cartridges. It allows having different cartridges quickly at hand and it works with C210 Cartridges.

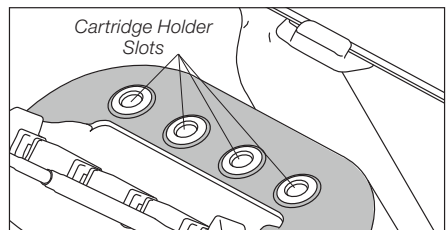

Wiper and Tip Cleaner

Select the tip cleaning option that best suits your needs and improve the tip thermal transfer.

CL0301 Wiper for B-IRON Charging-Base includes an anti-splash area that prevents solder particles from splashing onto the working area, keeping the workplace clean.

It also includes a temperature-resistant wiper area for removing excess solder by gently tapping or wiping the cartridge tip on it.

Tapping

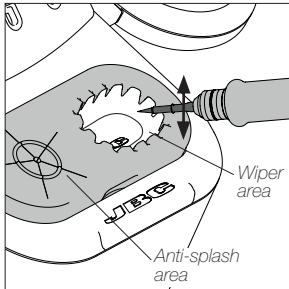

Tap gently to remove excess solder.

Wiping

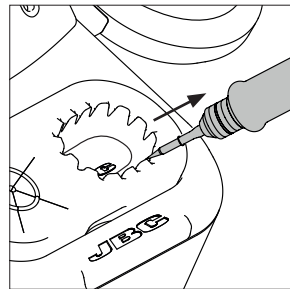

Use the slots to remove remaining particles.

Brass Wool (inside)

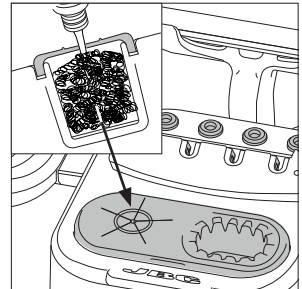

CL0300 Brass Wool is a very effective cleaning method. It leaves a small layer of solder on the tip, preventing oxidation between cleaning and rewetting.

Note: If the tip is very dirty, JBC recommends cleaning it first with the wiper to remove excess solder and then with the brass wool.

Replacing Brass Wool

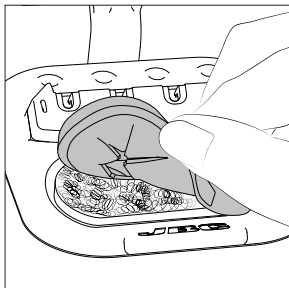

Lift the wiper membrane by using the recess on the edge. Remove the wiper and replace the brass wool with a new one. Make sure that the brass wool is on the far left and that there is space for the wiper on the right.

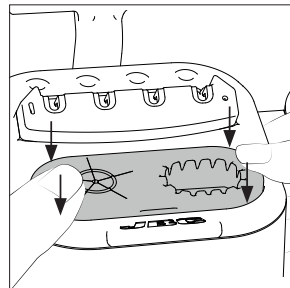

Press the wiper membrane down at the 4 corners until you feel it click into place. Make sure that the wiper membrane is inserted correctly all the way around.

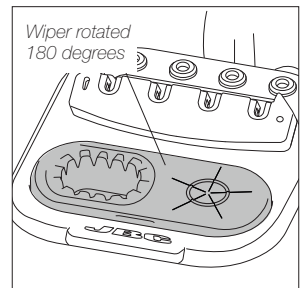

Note: The brass wool and the wiper positions can be reversed by rotating the anti-splash membrane 180 degrees.

JBC Software

No installation or initial download are required for newly purchased JBC products. Both JBC display and tools come with its current software/firmware installed and updated, and are ready to use.

Note:

App: If a third-party display (tablet or smartphone) is used, the B-IRON app must be downloaded from JBC’s web page and installed on the device.

Firmware: The tool’s firmware is not automatically updated and the updates must be carried out manually by the user. To do so, follow the instructions on the next page.

App Versions

Make sure that the required app version is installed on the display (tablet or smartphone):

- Handles require app versions **1.6** or higher.
- Tweezers require app versions **1.7** or higher.

App Installation

On **JBC’s portable display** (*Android*), the B-IRON app is already installed.

On the **user’s smartphone or tablet** (*Android / iOS*), go to the App Store/Play Store and search for “JBC B.IRON” on the search bar. **Note:** Internet connection is required to download the app.

Alternatively, scan these QR codes to access the B-IRON app page directly:



App Update

Display with Internet connection (*Android / iOS*)

Update the app via Google Play (*Android*) or the App Store (*iOS*).

Display without Internet connection (*Android*)

Download JBC’s installer program to another device with an Internet connection from JBC’s website: <https://www.jbctools.com/jbcsoftware.html>



Then copy the downloaded program to the internal storage of the display used with B-IRON. Access the internal storage of the display and run the downloaded program. Once the program is completed, the app will be updated to the latest version.

Note: For JBC displays, swipe down to open the internal storage folder.

Downloading the Tool Firmware Update File

Display with Internet connection:

Download the firmware update file to the display used with B·IRON from <https://www.jbctools.com/jbcsoftware.html>. Go to the internal folder and unzip the downloaded file.

Display without Internet connection:

Download the firmware update file to another device with an Internet connection from JBC's website: <https://www.jbctools.com/jbcsoftware.html> and unzip the downloaded file.

Then do as described in the table.

PDS JBC's display (android)	Other android devices	iOS devices
Copy the unzipped files on the device used with B·IRON:		
Folder:	Folder:	Path:
\Internal shared storage\Android\data\es.infinitysource.jbc_soldering.JBCBiron\files	\Internal shared storage\Android\data\com.jbctools.jbcbiron\files	Files > On my iPad > JBC B.iron 

Executing the Tool Firmware Update File

Tool firmware updates are not executed automatically; they must be carried out by the user.

On the display you are using with B·IRON, and with the latest app version installed, access the B·IRON app:



Select the tool you want to update. Then in the main menu select "update".

Note: At least one tool must be connected to see the expanded menu options.

Main menu with expanded menu options

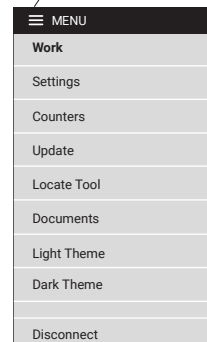

Executing the Tool Firmware Update File *(continuation)*

If the downloaded tool firmware update file contains a newer version than the one already installed, the current and new version are displayed (1). Tap “Update” to start the update (2).

The update process takes about 10 minutes.

Note: If the firmware update is interrupted, the app automatically recognizes this and starts a new update process. “Device needs recovery” appears on the top left corner of the display. Press the “Update” button (2) in the pop-up window to continue the firmware update.

The B-IRON status light continuously changes its color during the update process.

Once the update is completed, “Tool updated” (3) will be displayed.

If “No new version available” is displayed (4), no update is possible or required.

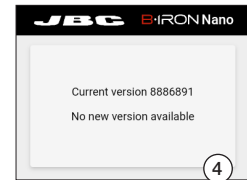
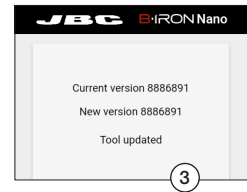
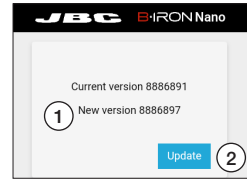

Accessories

B-IRON Display Holder 10" to 13"

Ref. 0031246

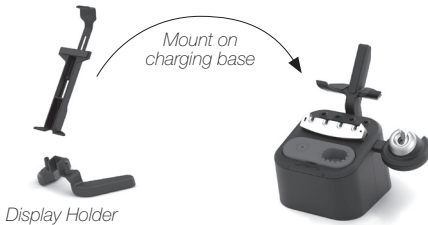

In addition to the display holder supplied with the B-IRON station, JBC offers a holder for tablet sizes between 10" and 13".

Accessories *(continuation)*

Soldering Tools for B-IRON Stations

B-NANO*

Nano Handle for B-IRON



Ergonomic and lightweight soldering handle. Designed for use in labs and high-precision soldering in hard-to-reach areas.

Works with C115 Cartridges.

B-TWEEZERS*

Nano Tweezers for B-IRON



Powerful and efficient soldering tweezers. Designed for use in labs and soldering rework jobs.

Works with C115 Cartridges.

B-100*

Light Handle for B-IRON



Ergonomic and lightweight soldering handle. Designed for use in labs and individual soldering jobs.

Works with C210 Cartridges.

B-500*

Handle for B-IRON



Powerful and efficient soldering handle. Designed for use in production and intensive soldering jobs.

Works with C210 Cartridges.

** Cartridges not included.*

To charge the tools, a B-IRON charging base or station is needed.

Required app version: For handles 1.6 or higher and for tweezers 1.7 or higher.

Accessories *(continuation)*

Tool Expansion Kits for B-IRON Stations

B-NANO K*

Nano Handle Expansion Kit

This kit allows extending B-IRON stations with B-NANO Handle.

Works with C115 Cartridges.



B-TWEEZERS K*

Nano Tweezer Expansion Kit

This kit allows upgrading B-IRON stations to a rework station by adding B-TWEEZERS.

Works with C115 Cartridges.



B-100 K*

Light Handle Expansion Kit

This kit allows extending B-IRON stations with B-100 Light Handle.

Works with C210 Cartridges.



B-500 K*

Handle Expansion Kit

This kit allows extending B-IRON stations by adding B-500 Handle.

Works with C210 Cartridges.

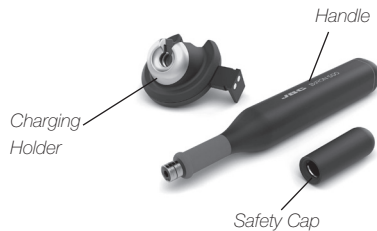

* Cartridges not included.

To charge the tools, a B-IRON charging base or station is needed.

Required app version: For handles 1.6 or higher and for tweezers 1.7 or higher.

Maintenance - B-IRON Handles

Replacing Soft Foam Grips - B5050 *includes 4 grips*

Inserting Fitters

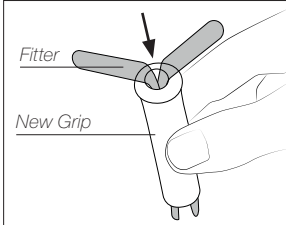

Insert the fitters into the new grip.

Assembling Grips

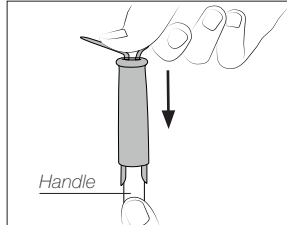

Push the grip with the fitters onto the handle.

Removing Fitters

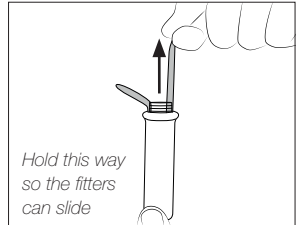

To remove the fitters, hold the grip and pull the fitters out. Use pliers if necessary.

Sealing Plugs

The sealing plug prevents undesirable flux vapors or particles from entering the handle and its usage is highly recommended. If the sealing plug is not used, this can lead to incorrect cartridge contact and may render the tool unusable.

Note: Check the condition of the plug periodically and replace it as soon as wear or cracking is detected.



Before replacing the sealing plug, disconnect the handle from the station and make sure the device has cooled down.

Sealing plug references:

(each ref. includes 10 sealing plugs)

Handle	Sealing Plug Ref.
B-NANO	OB5000
B-100 and B-500	OB4000

Replacing Sealing Plug for B-100 & B-500 Handles - OB4000 *includes 10 sealing plugs*

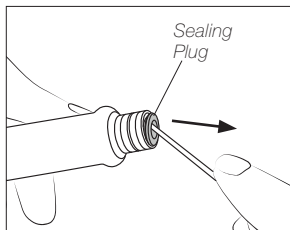

Introduce a small shaft or screwdriver, not deeper than 8 mm, lift and pull the sealing plug. Never use a cartridge to do this operation.

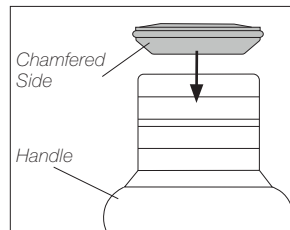

Push the sealing plug inside the handle.

Note: The chamfered side of the sealing plug has to be positioned towards the handle.

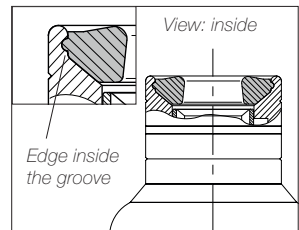

Make sure the sealing plug is placed correctly.

The edge of the sealing plug must rest in the groove of the tool bushing.

Maintenance - Station and Tools

Before carrying out maintenance, always extract the cartridge from the tool and disconnect the charging base from the mains. Allow the equipment to cool down.

- Use a damp cloth to clean the casing and the tool. Alcohol can only be used to clean the metal parts.
- Periodically check that the metal parts of the tool and charging holder are clean so that the charging works properly.
- Keep the tip surface clean and tinned prior to storage in order to avoid tip oxidation. Rusty and dirty surfaces reduce heat transfer to the solder joint.
- Do not use liquids such as alcohol, thinner or benzene to clean the portable display.
- Repairs should only be performed by a JBC authorized technical service.

Clean the contact surfaces regularly to ensure that the tool gets charged correctly.



Safety - Battery



It is imperative to follow safety guidelines to prevent electric shock, injury, fire or explosion.

- **Caution:** This product contains lithium-ion batteries. Mishandling or improper use may result in fire, explosion, or personal injury.
- Always use the provided charger. Do not use damaged chargers or batteries.
- Never attempt to disassemble or modify the batteries or the product. Doing so may lead to electric shock, fire, or damage to the product.
- In the event of damage, leakage, or overheating of the batteries, discontinue use immediately and contact customer support or JBC technical service facility.
- Dispose of devices with batteries inside, responsibly according to regulations. They must be disposed of in accordance with local regulations so that they can be recycled.
- Do not throw devices with batteries into household waste and do not dispose of them in fire or water.

Safety



It is imperative to follow safety guidelines to prevent electric shock, injury, fire or explosion.

- Do not use the units for any purpose other than soldering or rework. Incorrect use may cause a fire.
- The power cord must be plugged into approved bases. When unplugging it, hold the plug, not the wire.
- Do not attempt to dismantle or open the housing of the tool as it may cause damage.
- Do not work on electrically live parts.
- The tool should be placed in the charging holder when not in use in order to charge the batteries.
- The soldering tip, the metal part of the tool and the charging holder may still be hot even when the station is turned off.
- Do not leave the tool unattended when it is on.
- Avoid flux coming into contact with skin or eyes to prevent irritation.
- Be careful with the fumes produced when soldering.
- Keep your workplace clean and tidy. Wear appropriate protection glasses and gloves when working to avoid personal harm.
- Utmost care must be taken with liquid tin waste, which can cause burns.
- This appliance can be used by children over the age of eight and also persons with reduced physical, sensory or mental capabilities or lack of experience provided that they have been given adequate supervision or instruction concerning the use of the appliance and understand the hazards involved. Children must not play with the appliance.
- Maintenance must not be carried out by children unless supervised.
- Do not expose the portable display to high temperatures, humidity or dust. Avoid direct sunlight.
- Do not drop the portable display or the tool, as it may cause damage or malfunction.
- Do not disconnect your device when it is in file transfer mode.
- Do not use the portable display in places where wireless communications are restricted.

Notes

Specifications

B-IRON DUAL 500

Dual Battery-Powered Soldering Station

Ref. **BISS-5B** - with Portable Display

Ref. **BISS-5QB** - without Portable Display

Charging-Base

- Input: 100 V - 240 V 50 / 60 Hz
- Nominal Power: 40 W
- Tool Output: 12 V / 1000 mA
- USB Output: 5 V / 1000 mA

B-500 Handle

- Peak Power (Tool): 24 W
- Battery: Li-Ion 7.4 V / 750 mAh
- Charge Time: 60 minutes
- Selectable Temperature: 100 - 450 °C / 210 - 840 °F
- Idle Temp. Stability (still air): ± 1.5 °C / ± 3 °F
- Temp. Accuracy: ± 3 % (using reference cartridge)
- Connections: Bluetooth Low Energy (BLE)
- Ambient Operating Temp.: 10 - 50 °C / 50 - 122 °F
- Tool Weight: 70 g / 0.154 lb

Portable Display 7"

- Display Dimensions: 7" / 7 in

Ref. **BISS-5B** with Portable Display:

- Total Net Weight: 2.13 kg / 4.70 lb
- Total Package Dimensions/Weight:
(L x W x H) 265 x 223 x 160 mm / 2.74 kg
10.43 x 8.78 x 6.30 in / 6.04 lb

Ref. **BISS-5QB** without Portable Display:

- Total Net Weight: 1.68 kg / 3.70 lb
- Total Package Dimensions/Weight:
(L x W x H) 225 x 223 x 160 mm / 2.25 kg
8.86 x 8.78 x 6.30 in / 4.96 lb

Complies with CE standards.

ESD safe (to comply with ESD requirements, see page 4).

JBC

Warranty

JBC's 2 year warranty covers this equipment against all manufacturing defects, including the replacement of defective parts and labor.

Warranty does not cover product wear or misuse.

In order for the warranty to be valid, equipment must be returned, postage paid, to the dealer where it was purchased.

Get 1 extra year JBC warranty by registering here:
<https://www.jbctools.com/productregistration/>
within 30 days of purchase.

If you register, you will receive e-mail notifications about new software updates for your registered product.



This product should not be thrown in the garbage.

In accordance with the European directive 2012/19/EU, electronic equipment at the end of its life must be collected and returned to an authorized recycling facility.

CE EAC UK
CA

www.jbctools.com

0034645-240325