

JBC

www.jbctools.com

INSTRUCTION MANUAL

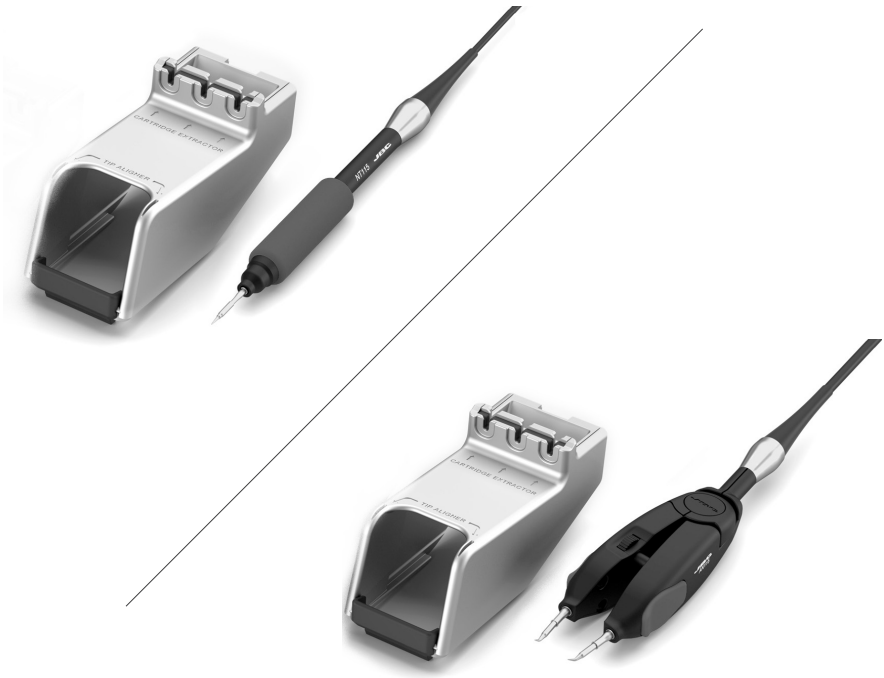

NA103 / NA104

Updating Kit C115 Nano Handle
Updating Kit C115 Nano Tweezers

This manual corresponds to the following references:

0033103 - NA103
Updating Kit C115 Nano Handle

0033104 - NA104
Updating Kit C115 Nano Tweezers

Packing List

The following item is included in
Ref. **0033103**:

*Soft Foam Grip
(Ref. see page 5)*



Nano Handle 1 units
Ref. NT115-A

The following item is included in
Ref. **0033104**:



Adjustable Nano Tweezers 1 unit
Ref. AN115-A

The following items are included in Ref. **0033103** and Ref. **0033104**:



Splashguard 1 units

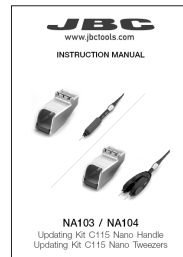

Manual 1 unit
Ref. 0033002

Connection Example *with 2 Nano Handles*

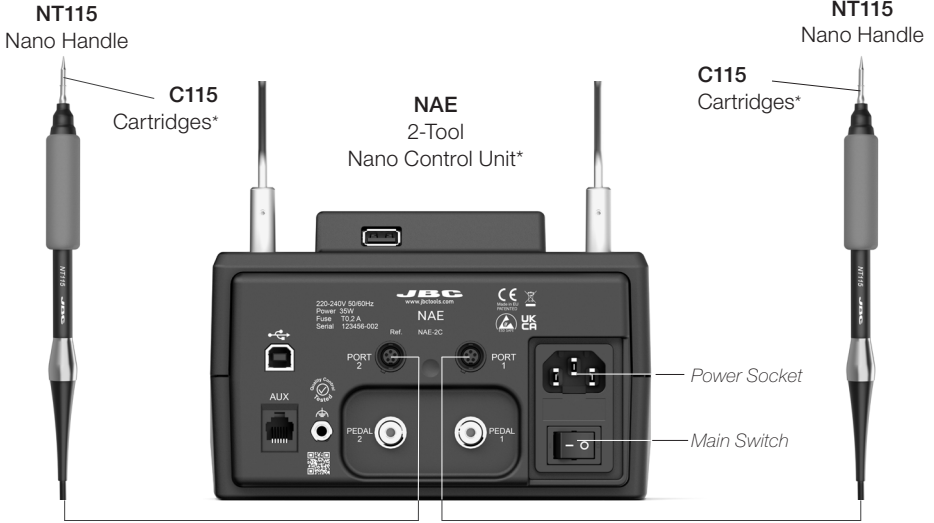

Connection Example *with Nano Handle and Nano Tweezers*

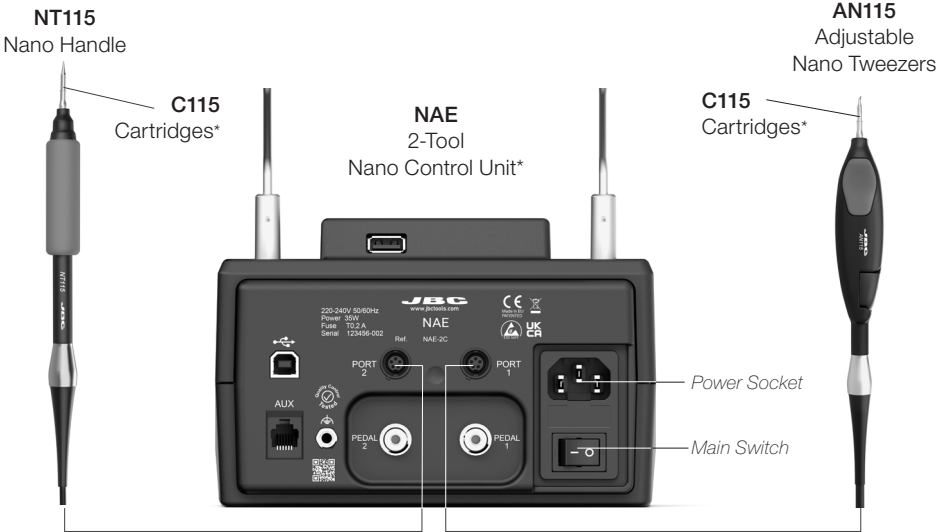

Note:

To use NT115-A, AN115-A and C115 cartridges with control unit versions NAE-A and NAE-B, the software must be updated to a software version number higher than 8886229. See the software updater available at www.jbctools.com/software.html

**not included, sold separately*

Changing the Splashguard

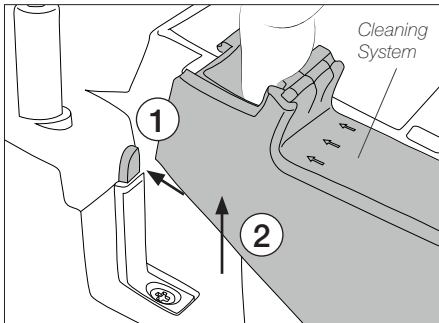

Press backward the tap (1) to remove the cleaning system (2) from the station.

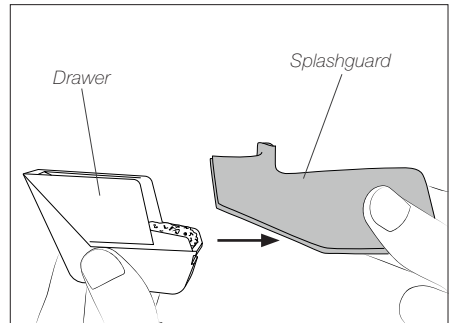

Remove the splashguard from the drawer and insert the new one.
Put the cleaning system back to the station.

Changing Cartridges on NT115 Handle

Removing

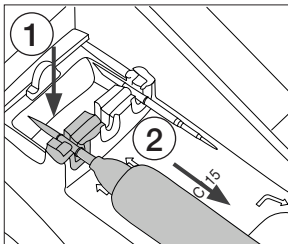

Place the cartridge into the extractor slot (1) and pull the handle to remove the cartridge (2).

Inserting

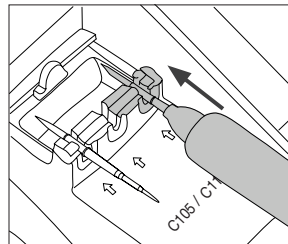

Push the new cartridge into the handle until the reference ring*.

Aligning

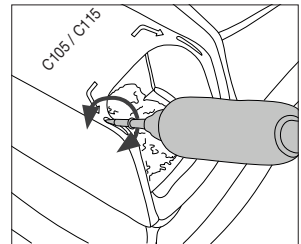

Use the holes to rotate the cartridges for proper alignment.

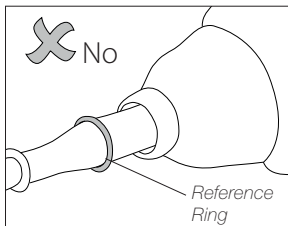

*Important

It is essential to insert the cartridges up to the reference ring for a proper connection.

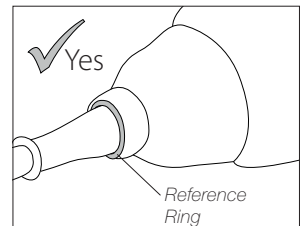

Changing Grips on NT115 Handle

Soft foam grips for NT115 Nano Handles ensure better manual control of the handle and greater comfort when working.

Soft Foam Grips are available in 3 different colors:

N8662 green

Ref. 0018662 (incl. 4x grips)

N3308 blue

Ref. 0023308 (incl. 4x grips)

N3309 black

Ref. 0023309 (incl. 4x grips)

Replace the grips easily using the included fitters as shown in the following pictures.

Inserting Fitters

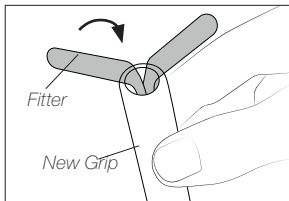

Insert the fitters into the new grip.

Assembling Grip

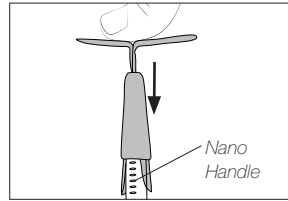

Push the grip with the fitters onto the nano handle.

Removing Fitters

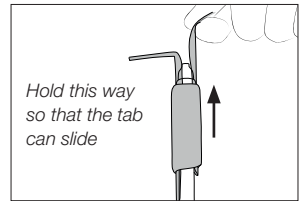

To remove the fitters, hold the grip and pull the fitters out. Use pliers if necessary.

Compatible Cartridges for NT115 Handle

Nano Handle **NT115** works with **C115** cartridges. Find the model that best suits your soldering needs at www.jbctools.com

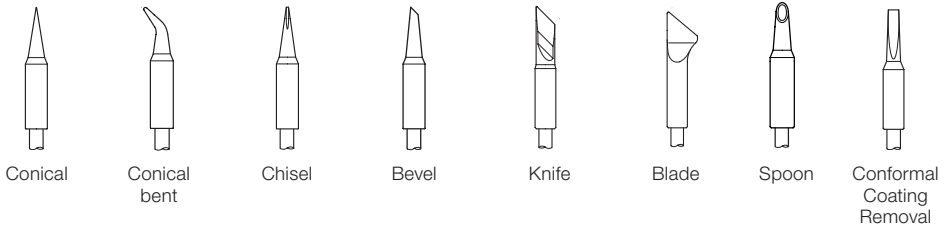

Changing Cartridges on AN115 Tweezers

Save time and change cartridges safely without having to switch the station off.

Removing

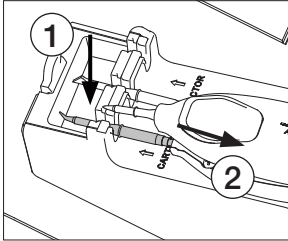

Place the cartridge into the extractor slot (1) and pull the tweezers to remove the cartridge (2).

Inserting

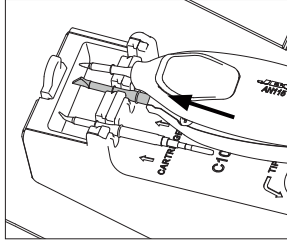

Push the tweezers onto the new cartridge until the reference ring*.

Aligning

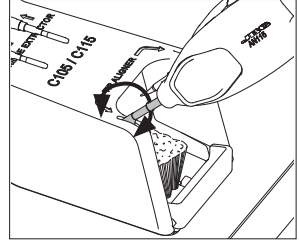

Use the holes to rotate the cartridges for a proper alignment.

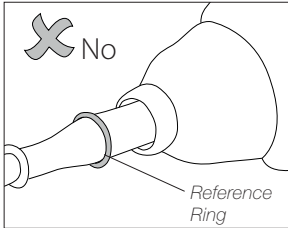

*Important

It is essential to insert the cartridges up to the reference ring for a proper connection.

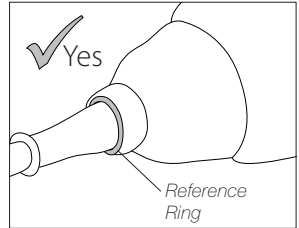

Vertical Cartridge Alignment

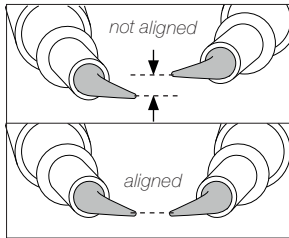
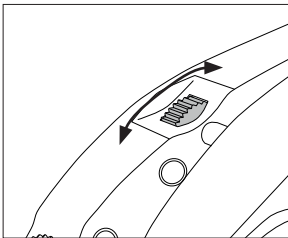

Turn the tweezers' hand wheel forwards or backward for a vertical cartridge alignment. One tip lines up with the other.

Compatible Cartridges for AN115 Tweezers

AN115 works with **C115** Cartridges. Find the model that best suits your soldering needs at www.jbctools.com.



Tweezer
Conical Bent



Tweezer Chisel



Blade

Maintenance

- Before carrying out maintenance or storage, always unplug the tool.
- Check periodically that the metal parts are clean to ensure it is detected when on the stand. Always use a damp cloth or alcohol.
- Periodically check all cables and tube connections.
- Replace any defective or damaged pieces. Use original JBC spare parts only.
- Repairs should only be performed by a JBC authorized technical service.

Safety



It is imperative to follow safety guidelines to prevent electric shock, injury, fire or explosion.

- Do not use the units for any purpose other than soldering or rework. Incorrect use may cause a fire.
- The power cord must be plugged into approved bases. Be sure that it is properly grounded before use. When unplugging it, hold the plug, not the wire.
- Do not work on electrically live parts.
- The tool should be placed in the stand when not in use in order to activate the sleep mode. The soldering tip or nozzle, the metal part of the tool and the stand may still be hot even when the station is turned off. Handle with care, including when adjusting the stand position.
- Do not leave the appliance unattended when it is on.
- Do not cover the ventilation grills. Heat can cause inflammable products to ignite.
- Avoid flux coming into contact with skin or eyes to prevent irritation.
- Be careful with the fumes produced when soldering.
- Keep your workplace clean and tidy. Wear appropriate protection glasses and gloves when working to avoid personal harm.
- Utmost care must be taken with liquid tin waste which can cause burns.
- This appliance can be used by children over the age of eight and also people with reduced physical, sensory or mental capabilities or lack of experience provided that they have been given adequate supervision or instruction concerning the use of the appliance and understand the hazards involved. Children must not play with the appliance.
- Maintenance must not be carried out by children unless supervised.

Specifications

NA103**Updating Kit C115 Nano Handle**Ref. **0000103**

- Total Net Weight: 173 g / 0.381 lb
- Package Dimensions/ Weight:
(L x W x H) 245 x 185 x 45 mm / 336 g
9.65 x 7.28 x 1.77 in / 0.741 lb

NA104**Updating Kit C115 Nano Tweezers**Ref. **0033104**

- Total Net Weight: 197 g / 0.434 lb
- Package Dimensions/ Weight:
(L x W x H) 245 x 185 x 45 mm / 354 g
9.65 x 7.28 x 1.77 in / 0.780 lb

Complies with CE standards.
ESD safe.

JBC

Warranty

JBC's 2 year warranty covers this equipment against all manufacturing defects, including the replacement of defective parts and labour.

Warranty does not cover product wear or misuse.

In order for the warranty to be valid, equipment must be returned, postage paid, to the dealer where it was purchased.



This product should not be thrown in the garbage.

In accordance with the European directive 2012/19/EU, electronic equipment at the end of its life must be collected and returned to an authorized recycling facility.



www.jbctools.com