

# JBC

[www.jbctools.com](http://www.jbctools.com)

Product  
website



## INSTRUCTION MANUAL



# NAE

## 2-Tool Nano Control Unit

This manual corresponds to the following references:

**NAE-9C** (100 V)

**NAE-1C** (120 V)

**NAE-2C** (230 V)

## Packing List

The following items are included:



**2-Tool Nano Control Unit** ..... 1 unit



**Cable Collector and Tool Holder** ..... 2 units  
Ref. CC2002



**Brass Wool** ..... 1 unit  
Ref. CL6210



**Metal Brush** ..... 1 unit  
Ref. CL2466



**Allen Key 1.5 mm** ..... 1 unit  
Ref. 0009848



**Power Cable** ..... 1 unit  
Ref. 0024092 (100 V)  
0023715 (120 V)  
0023714 (230 V)



**Manual** ..... 1 unit  
Ref. 0028953

## Features and Connections

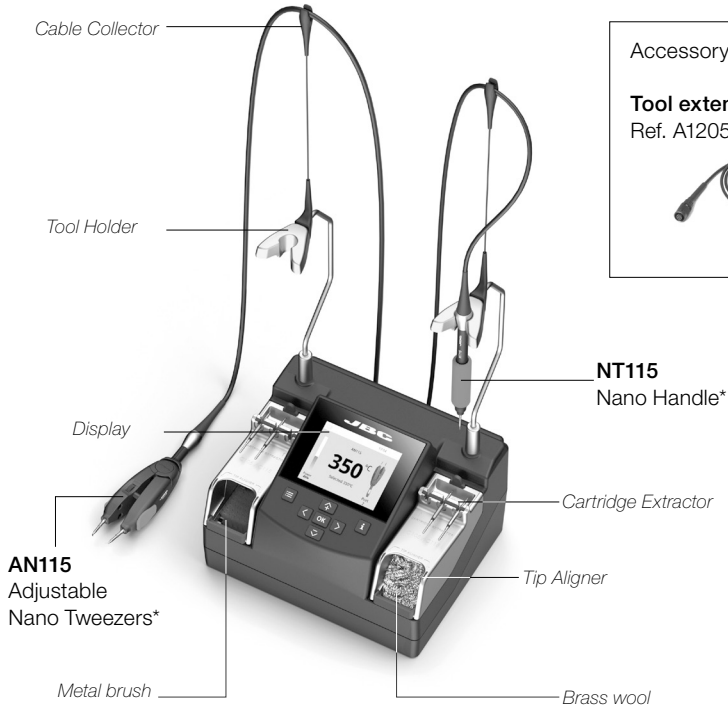

Accessory:

**Tool extension cord (1m)\***  
Ref. A1205

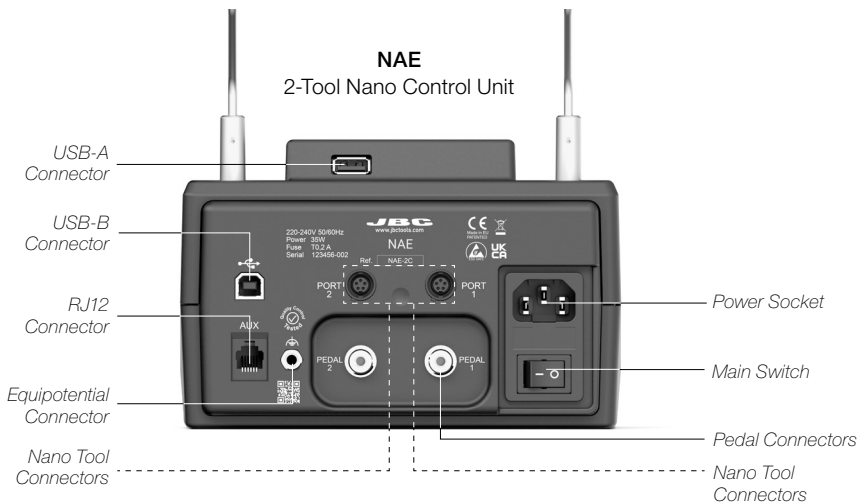

\* not included, sold separately

## Tool Holder Assembly

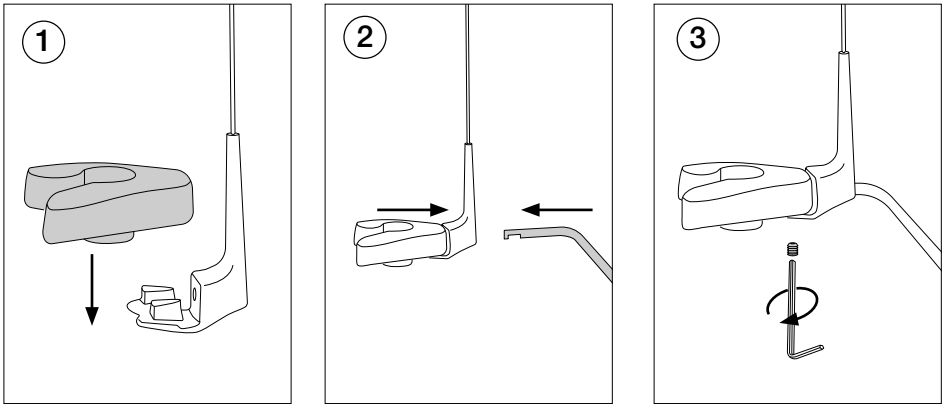

## Tool Holder Replacement

Loosen the screw (1) and remove the tool holder (2).

Insert the new tool holder (3) and tighten the screw (4).

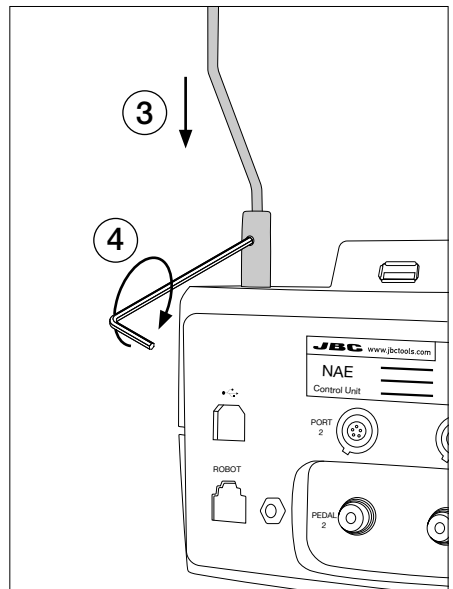
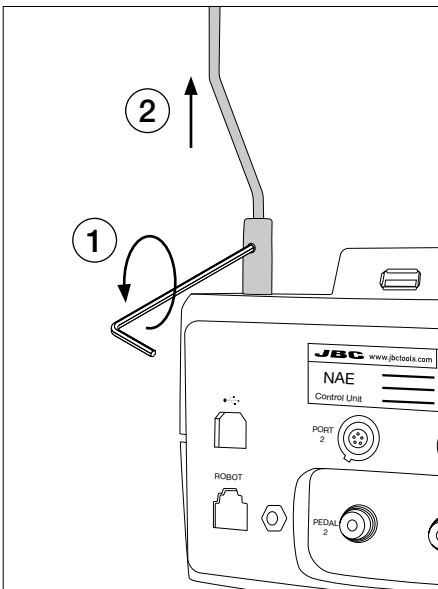

## Connection: FAE with NAE Control Unit

JBC's NAE control unit feature a connector that allows connecting it to the fume extractor using an RJ12 cable. This way, the fume extractor automatically starts extraction when the soldering tool is in use.

The minimum required software version for NEA control units is 8886160. To ensure correct operation, always update the control units with the latest available software Version, which can be downloaded from [www.jbctools.com/software.html](http://www.jbctools.com/software.html).



From version 8886784 on, the connected fume extractor can be configured and controlled through the peripherals menu (1) of the control unit.

Each control unit detects the fume extractor as "FAE\_a" (2). The tool that should activate the fume extraction needs to be configured on the control unit main menu through the tool menu option (3).

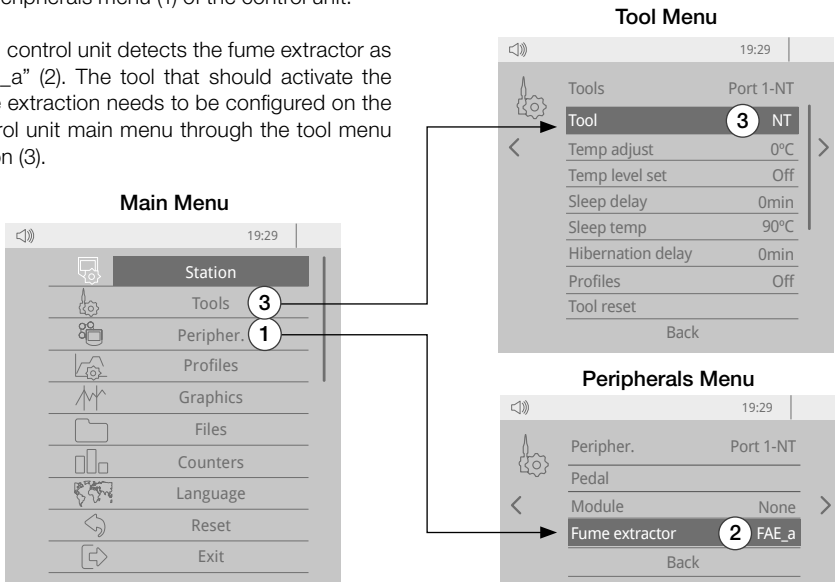

Connect up to 4 of any JBC control units to the fume extractor connectors (STATION 1, STATION 2, etc.) Each tool connected to these control units can start and stop the fume extractor.

# Work Screen

The work screen offers an **intuitive user interface** which provides **quick access** to station parameters. **Default PIN: 0105**

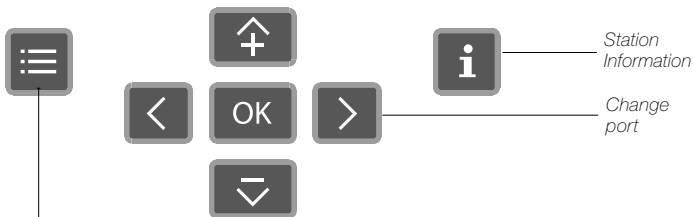
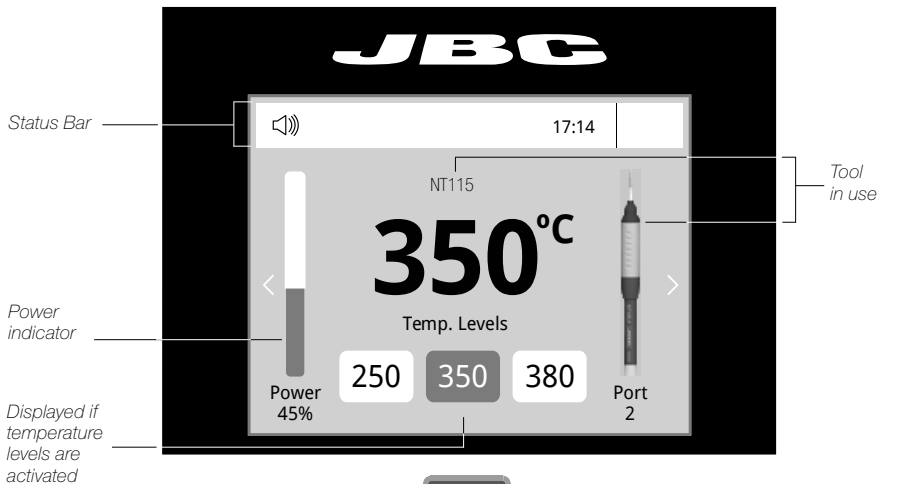

## Menu Options



Set the station parameters

**Station**



Set the tool parameters

**Tools**



Display the hours worked in each cycle

**Counters**



It is possible to choose the language from a list.

**Language**



Restore station parameters to default values

**Reset**

## Troubleshooting

Station troubleshooting available on the product page on [www.jbctools.com](http://www.jbctools.com)

## Advanced Functionalities



Graphics

It provides detailed graphics of tip temperature and power delivery in real time during solder joint formation for analysis purposes. This helps you decide how to adjust your process or which tip to use to obtain the best quality soldering.



Profiles

Designed to avoid thermal shock when soldering Ceramic Chip components like MLCC, this new and unique feature allows controlling the heating rate to gradually increase the temperature of the component through all the phases of the soldering process. Up to 25 fully configurable soldering profiles can be stored.

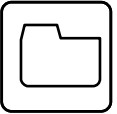

Files

### Export graphics

Insert a USB flash drive into the USB-A connector to save your soldering process in csv format.



Update

### Station update

Download the JBC Update File from [www.jbctools.com/software.html](http://www.jbctools.com/software.html) Insert the USB flash drive with the file downloaded to the station.

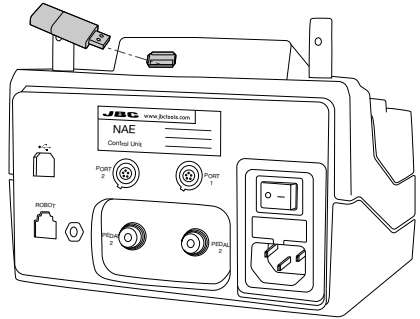

## System Notifications

The following icons will be displayed on the screen's status bar.



USB flash drive is connected.



Station software update. Press INFO to start the process.



Station is controlled by a PC.



Warning. Press INFO for failure description.



Station is controlled by a robot downloaded to the station.



Error. Press INFO for failure description, the type of error and how to proceed.

# Operation

## JBC's Exclusive Heating System

This revolutionary technology is able to recover tip temperature extremely quickly. This allows the user to work at a lower temperature. As a result, tip life increases by 5.

### 1. Work

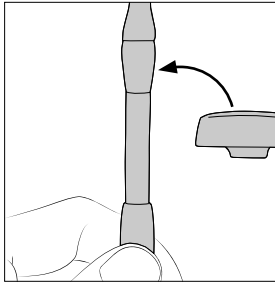

When the tool is lifted from the holder the tip will heat up to the selected temperature.

### 2. Hibernation

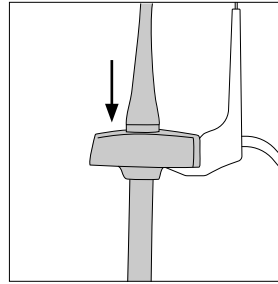

When the tool is in the holder, the power is cut off and the tool cools down to room temperature.

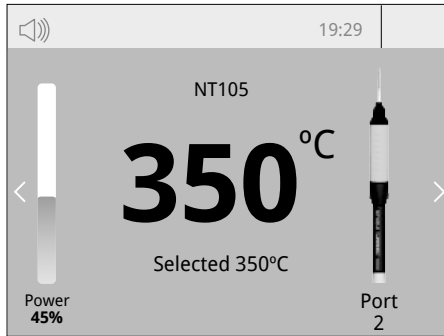

*Tool Settings:*  
· *Operating Temp. and Temp. Levels*

Press , select *Tool Settings* and activate the *Temp. Levels* option. Change Work temperature and Temp. Levels from 90 to 450 °C.

 or  steps of  $\pm 5$  °C / °F

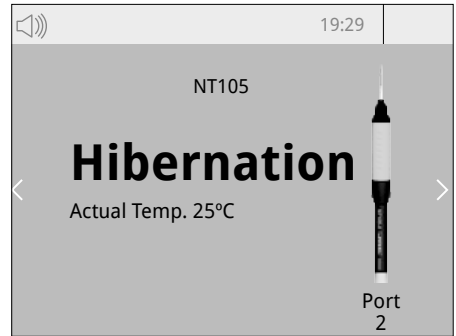

*Tool Settings:*  
· *Hibernation*

Change Hibernation delay from 0 to 60 min or no Hibernation.



## Changing Cartridges

Save time and change cartridges safely without having to switch the station off.

### Removing

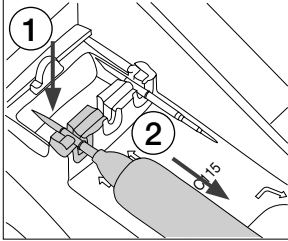

Place the cartridge into the extractor slot (1) and pull the handle to remove the cartridge (2).

### Inserting

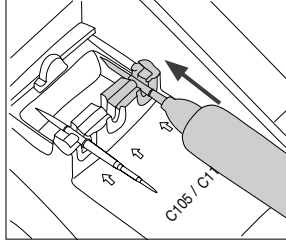

Push the new cartridge into the handle up to the reference ring\*.

### Aligning

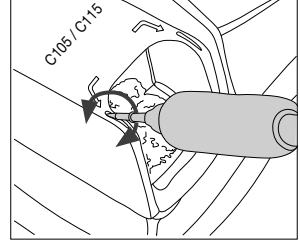

Use the holes to rotate the cartridges for proper alignment.

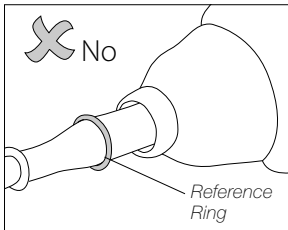

**\*Important**  
It is essential to insert the cartridges up to the reference ring for a proper connection.

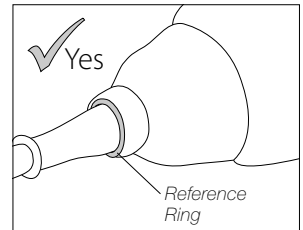

# Example: Chip Component Rework Process using Tweezers and Pedal

The pedal is frequently used to rework components with tweezers.

AN115, JBC's Adjustable Nano Tweezers, is the most effective tool for desoldering chip components. It also facilitates rapid placement and soldering of the components by using P405 Pedal with JBC's NAE Control Unit.

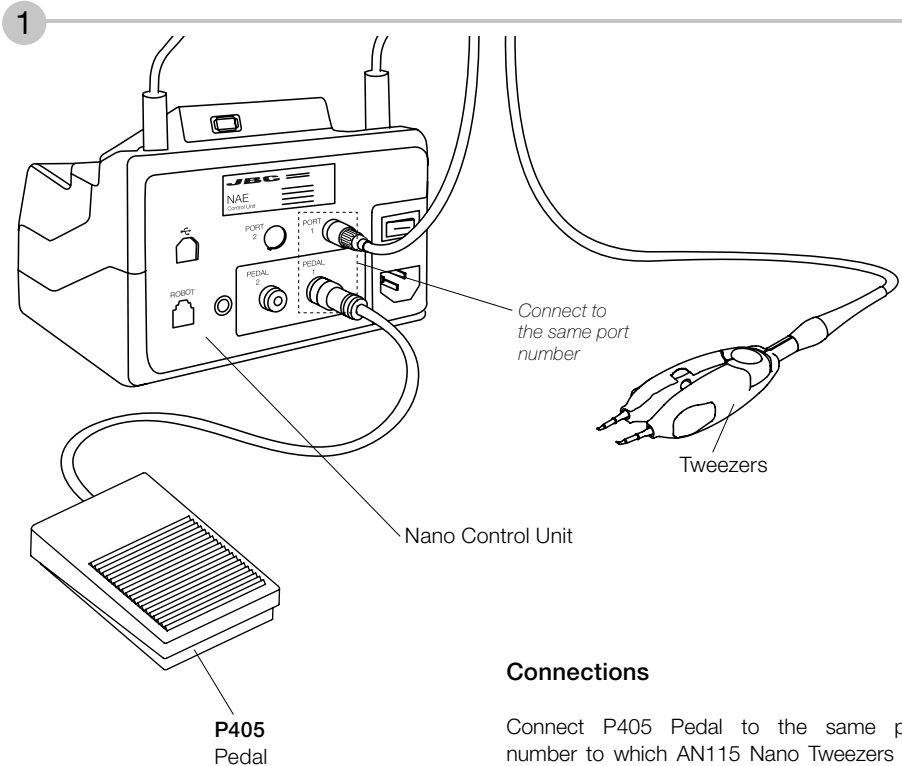

## Connections

Connect P405 Pedal to the same port number to which AN115 Nano Tweezers are connected.

In the Peripherals menu, for "Pedal Activation Mode" choose between "pressed" and "released".

2

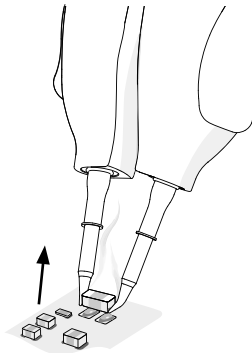

\* "Press Mode" previously selected

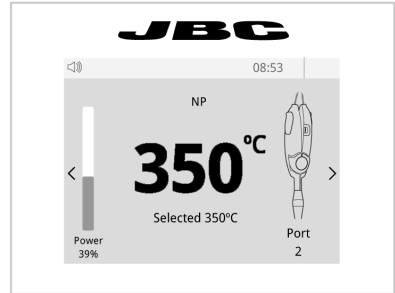

## Desoldering\*

Lift the tweezers from the holder, press and hold the pedal to activate the tweezers and desolder the component.

Once the pedal is released, the tweezers enter in hibernation mode and cool down.

3

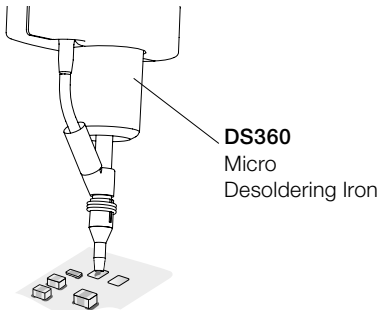

## Pad Cleaning

Clean the pads with JBC's desoldering tool DS360.

For this operation, JBC's desoldering station CS is needed.

4

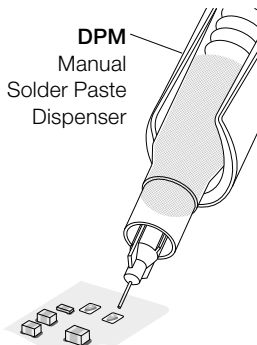

## Solder Paste Dispensing

Apply the needed amount of solder paste to solder the new chip component.

It is recommended to use JBC's DPM Solder Paste Dispenser.

5

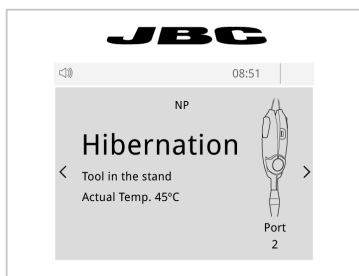
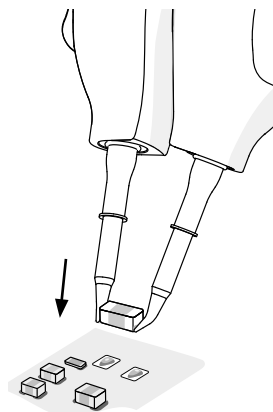

## Placing

Do not press the pedal.

Use the tweezers to position the component on the previously tinned pad.

### Note:

The inactive tweezers prevent the component from heating up prematurely.

6

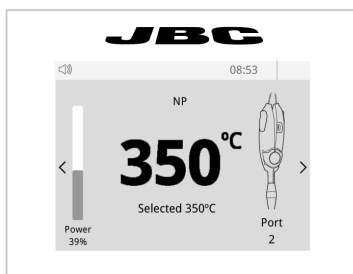
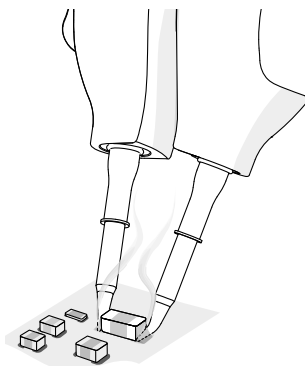

## Soldering

Once in position, press and hold the pedal to activate the tweezers and perform the soldering.

## Menu Options

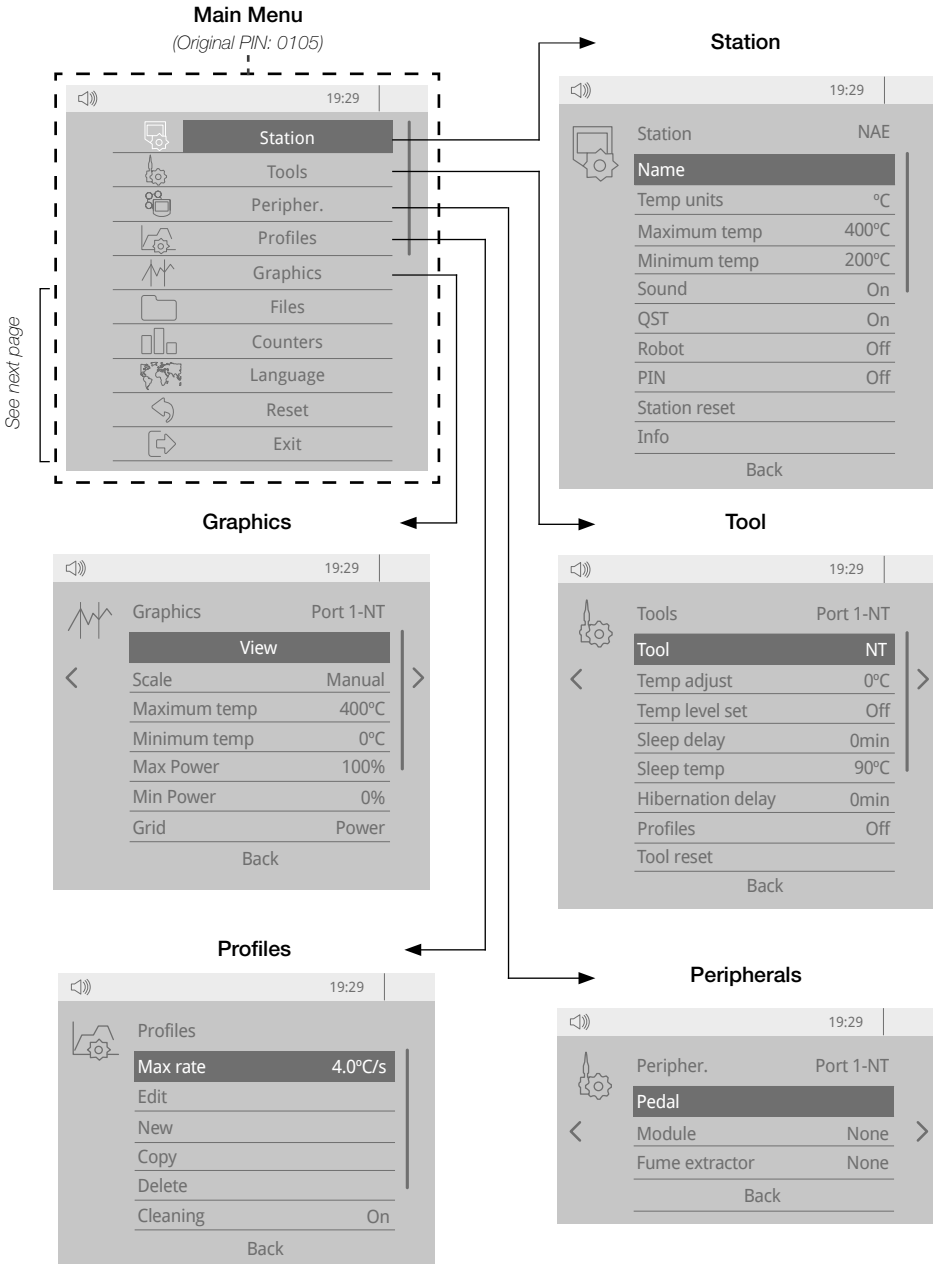

# Menu Options

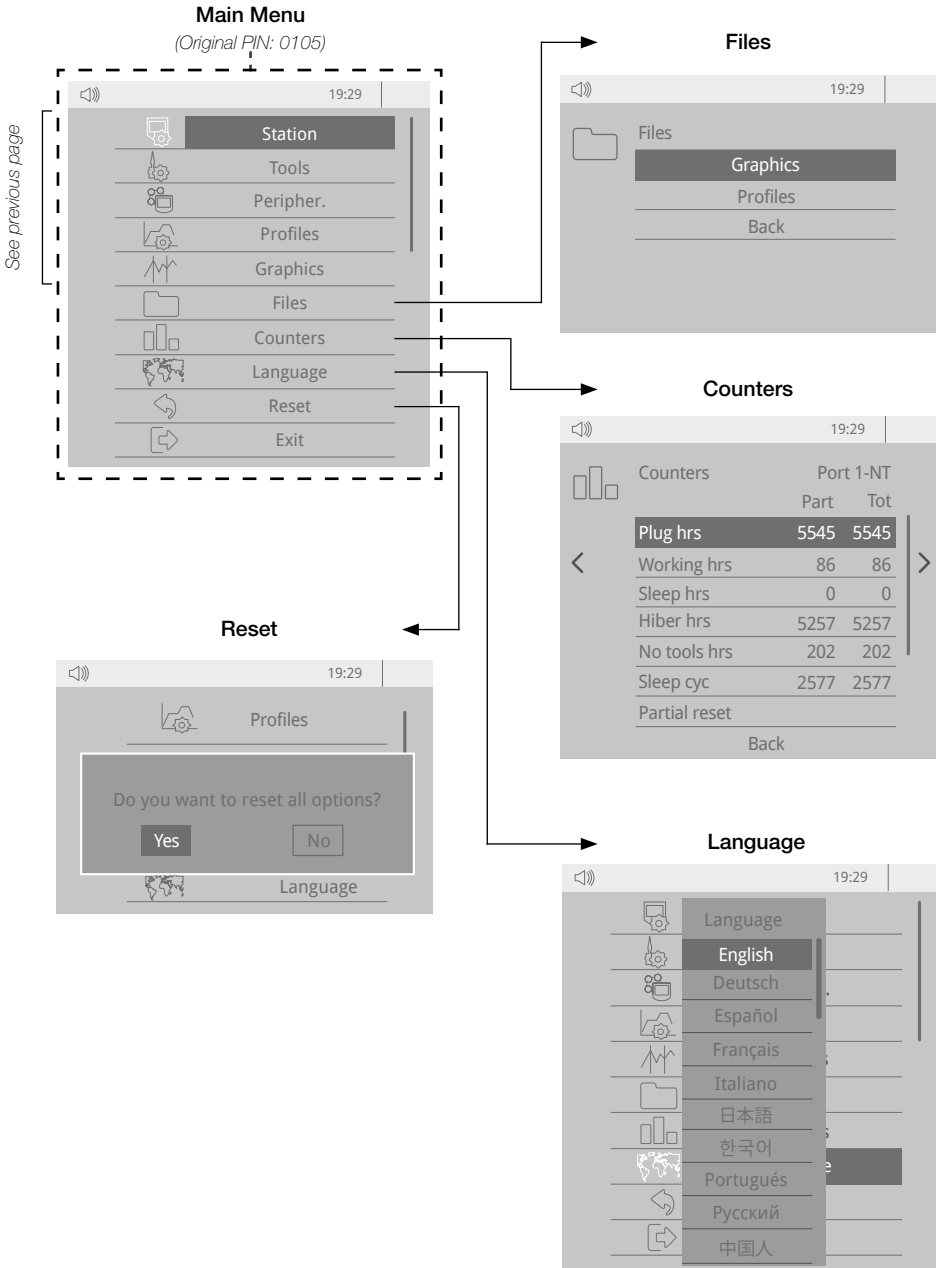

## Station

Setting	Description
Name	Allows to modify the station identifier.
Temp. Units	Allows to change the unit of temperature measurement: Celsius degrees or Fahrenheit degrees.
Maximum Temp. Minimum Temp.	Select the maximum/minimum temperature that can be set for the Work Mode.
Sound	Disable or enable the key sound.
QST	Enable or disable communication via USB connector for QST (Quality Soldering Traceability) libraries, available on JBC's website.
Robot	Disable or enable remote control with robot.
PIN	Allows to lock the parameters of the station using a four-digit code. The default code is 0105, but a new code can be set by simply entering some other four digits of choice when locking the parameters.
Station Reset	Restore the station settings to default.
Info.	Check specifications and information about the station.

## Tool

Setting	Description
Tool	Set the current settings (temperature adjust., sleep delay, sleep temp., etc.) for a tool when connected to a specific port.
Temp. Adjust.	Applies a positive/negative offset to the temperature.
Temp. Level Set	Enable or disable temperature levels.
Sleep Delay	Set Sleep delay from 0 to 9 min.
Sleep Temp.	Set Sleep temperature from 90 to 450 °C / 190 to 840 °F
Hibernation Delay	Set Hibernation delay from 0 to 60 min.
Profiles	Allows to create soldering profiles.
Tool Reset	Restore the tool settings to default.

## Peripherals

Setting	Description
Pedal	Configure the settings of connected pedals (for each port).
Module	Unused feature.
Fume Extractor	Disable or enable a fume extractor for each port.

## Profiles

Setting	Description
Max. Rate	Select the max. rate (temperatur/second) that can be set in profiles mode.
Edit	Edit an already existing profile.
New	Create a new profile.
Copy	Duplicate a profile.
Delete	Delete a profile.
Cleaning	Disable or enable cleaning time when working with a soldering profile.

## Graphics

Setting	Description
Scale	Set automatically or manually the scale of the graphics temperature.
Maximum Temp. Minimum Temp.	Select max./min. temperature of the graphics scale (manual mode).
Max. Power Min. Power	Select max./min. power supplied to the tool in %.
Grid	Choose between temperature or power to display in the grafics grid.



## Files

Setting	Description
Graphics	Export or delete temperature graphics.
Profiles	Export/Import or delete soldering profiles.

## Counters

Setting	Description
Plug Hrs.	Check how many hours the station has been on.
Working Hrs.	Check how many hours the station has been running in Work Mode.
Sleep Hrs.	Check how many hours the station has been in Sleep Mode.
Hiber. Hrs.	Check how many hours the station has been in Hibernation Mode.
No Tool Hrs.	Check how many hours the station has been with no tools connected.
Sleep Cycles	Check the number of sleep cycles the station has gone through.
Partial Reset	Resets all partial counters on the Part column.

## Language

Setting	Description
Language	Allows to change the software language between English, Spanish, German, Italian, French, Chinese, Korean, Portuguese, Russian or Japanese.

## Reset

Setting	Description
Reset	Reset every parameter and setting to default.

# Changing Soft Foam Grips

Soft foam grips for NT115 Nano Handles ensure better manual control of the handle and greater comfort when working.

Soft foam grips are available in 3 different colors:

**N8662** *green*

Ref. 0018662 (incl. 4x grips)

**N3308** *blue*

Ref. 0023308 (incl. 4x grips)

**N3309** *black*

Ref. 0023309 (incl. 4x grips)

Replace the grips easily using the included fitters as shown in the following pictures.

## Inserting Fitters

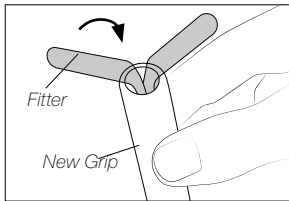

Insert the fitters into the new grip.

## Assembling Grip

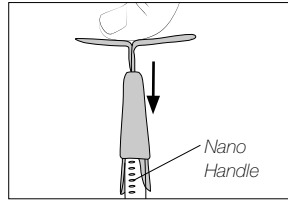

Push the grip with the fitters onto the nano handle.

## Removing Fitters

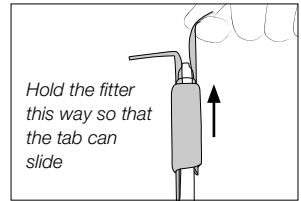

To remove the fitters, hold the grip and pull the fitters out. Use pliers if necessary.

# Changing the Tip Cleaning System

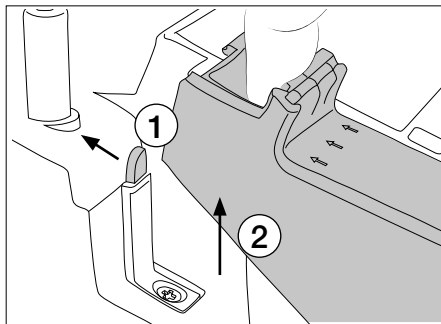

Pull back the tab (1) to remove the cleaning system (2).

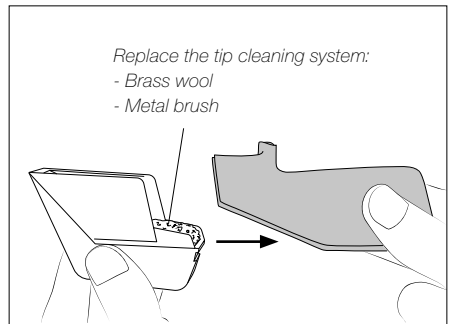

Remove the splashguard from the drawer and insert a new one.

Reattach the cleaning system to the station.

## Maintenance

Before carrying out maintenance, always switch the device off and disconnect it from the mains. Allow the equipment to cool down.

- Clean the station screen with a glass cleaner or a damp cloth.
- Use a damp cloth to clean the casing and the tool. Alcohol can only be used to clean the metal parts.
- Periodically check that the metal parts of the tool and stand are clean so that the station can detect the tool's status.
- Maintain the tip surface clean and tinned prior to storage in order to avoid tip oxidation. Rusty and dirty surfaces reduce heat transfer to the solder joint.
- Periodically check all cables and tubes.
- Replace any defective or damaged pieces. Use original JBC spare parts only.



- Replace a blown fuse as follows:

**1.** Pull off the fuse holder and remove the fuse. If necessary use a tool to lever it off.

**2.** Press the new fuse into the fuse holder and replace it in the station.

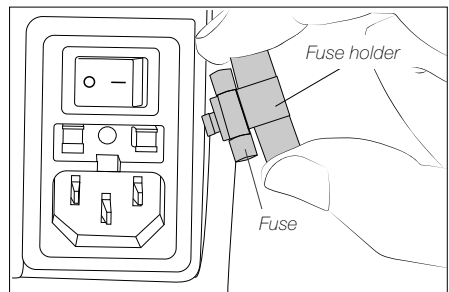
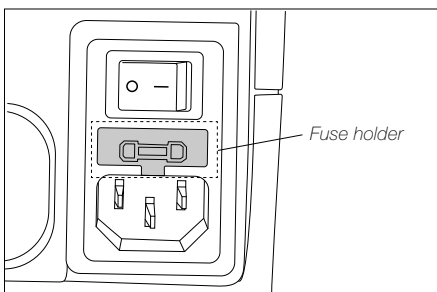

- Repairs should only be performed by a JBC authorized technical service.

# Safety



**It is imperative to follow safety guidelines to prevent electric shock, injury, fire or explosion.**

- Do not use the units for any purpose other than soldering or rework. Incorrect use may cause a fire.
- The power cord must be plugged into approved bases. Be sure that it is properly grounded before use. When unplugging it, hold the plug, not the wire.
- Do not work on electrically live parts.
- The tool should be placed in the stand when not in use in order to activate the sleep mode. The soldering tip or nozzle, the metal part of the tool and the stand may still be hot even when the station is turned off. Handle with care, including when adjusting the stand position.
- Do not leave the appliance unattended when it is on.
- Do not cover the ventilation grills. Heat can cause inflammable products to ignite.
- Avoid flux coming into contact with skin or eyes to prevent irritation.
- Be careful with the fumes produced when soldering.
- Keep your workplace clean and tidy. Wear appropriate protection glasses and gloves when working to avoid personal harm.
- Utmost care must be taken with liquid tin waste which can cause burns.
- This appliance can be used by children over the age of eight and also people with reduced physical, sensory or mental capabilities or lack of experience provided that they have been given adequate supervision or instruction concerning the use of the appliance and understand the hazards involved. Children must not play with the appliance.
- Maintenance must not be carried out by children unless supervised.





## Specifications

### NAE

#### 2-Tool Nano Control Unit

Ref. **NAE-9C** 100 V 50/60 Hz. Input fuse: 0.5 A. Output: 8.5 V.

Ref. **NAE-1C** 120 V 50/60 Hz. Input fuse: 0.5 A. Output: 8.5 V.

Ref. **NAE-2C** 230 V 50/60 Hz. Input fuse: 0.2 A. Output: 8.5 V.

- Peak Power (Tool): 14 W per tool
- Selectable Temperature: 90 - 450 °C / 190 - 840 °F
- Idle Temp. Stability (still air):  $\pm 1.5$  °C /  $\pm 3$  °F (meets and exceeds IPC J-STD-001)
- Temp Accuracy:  $\pm 3$  % (using reference cartridge)
- Temp Adjustment:  $\pm 50$  °C /  $\pm 90$  °F (through station menu setting)
- Tip to Ground Voltage/Resistance: Meets ANSI / ESD S20.20
- Connections: USB-A / USB-B / pedal connectors  
RJ12 connector
- Ambient Operating Temp: 10 - 50 °C / 50 - 122 °F
- Control Unit Dimensions:  
(L x W x H) 140 x 170 x 125 mm  
5.51 x 6.69 x 4.92 in
- Total Net Weight: 2.12 kg / 4.67 lb
- Total Package Dimensions/Weight:  
(L x W x H) 280 x 280 x 164 mm / 3.31 kg  
11.02 x 11.02 x 6.46 in / 7.30 lb

Complies with CE standards.  
ESD Safe.

# JBC

---

## Warranty

JBC's 2 year warranty covers this equipment against all manufacturing defects, including the replacement of defective parts and labor.

Warranty does not cover product wear or misuse.

In order for the warranty to be valid, equipment must be returned, postage paid, to the dealer where it was purchased.

**Get 1 extra year JBC warranty by registering here:**

**<https://www.jbctools.com/productregistration/>**

**within 30 days of purchase.**

If you register, you will receive e-mail notifications about new software updates for your registered product.

---



This product should not be thrown in the garbage.

In accordance with the European directive 2012/19/EU, electronic equipment at the end of its life must be collected and returned to an authorized recycling facility.

CE EAC UK  
CA

[www.jbctools.com](http://www.jbctools.com)